

Pull/Push DC Solenoids for Diesel Engines – RP Series



Features

- One Solenoid For Pull/Push Operation
- No Internal Switches
- Reduce Coil Burnout
- Boost Reliability
- Reduce Adjustments
- High Force–Small Size
- Can Be Used With Most Engines Start Systems
- SD85 Solenoid Drive Time Delay Available To Greatly Reduce Possibility Of Coil Burnout And Facilitate Low Current Piloted Operation.

Murphy push/pull DC Solenoids provide single unit versatility for engine applications, such as shutdown.

A choice of two models and two voltages is available. All models come complete with return spring and rubber seal boot. See the next page for specifications and options.

Basic Models

Models RP2307B and RP2308B give a full one inch (25 mm) stroke at 11 pounds (49 N) and hold up to 23 pounds (102 N) at full voltage, continuous duty.

They will operate at any stroke less than maximum; refer to the chart shown on page 2.

Models RP2309B and RP2310B can pull 14 pounds (62 N) with a one-and-a-half inch (38 mm) stroke. They hold up to 34 pounds (151 N) at full voltage, continuous duty. See the chart on page 2 for holding force at any stroke less than maximum.

SD85 Solenoid Drive Time Delay

Using the SD85 ensures the energize coil is only powered for 1-2 seconds with each operation. If the plunger does not seat in that time, it is highly unlikely it will seat. The hold coil is energized as long as the signal to the SD85 is active. This insures long life of the RP solenoid.

MODEL & PART NUMBERS: Model No.	DC SOLENOIDS & ACCESSORIES Description	SHIPPING WEIGHT ozs (kg)
RP2307B	12 VDC, 1 in. (25 mm) stroke, 11 lbf (49 N) pull, 23 lbf (102 N) hold	24 ozs (0.7 kg)
RP2308B	24 VDC, 1 in. (25 mm) stroke, 11 lbf (49 N) pull, 23 lbf (102 N) hold	24 ozs (0.7 kg)
RP2309B	12 VDC, 1-1/2 in. (38 mm) stroke, 14 lbf (62 N) pull, 34 lbf (151 N) hold	48 ozs (1.4 kg)
RP2310B	24VDC, 1-1/2 in. (38 mm) stroke, 14 lbf (62 N) pull, 34 lbf (151 N) hold	48 ozs (1.4 kg)
65-01-0108	Clevis yoke assembly	1 ozs (.03 kg)
65-01-0110	Clevis yoke chain assembly	2 ozs (.04 kg)
40-05-0315	Threaded rod (1-1/2 in.)	.05 ozs (.001 kg)
00-00-2457	RPS in-line ball joint	.05 ozs (.001 kg)
00-00-2458	RPS 90° ball joint	1 ozs (.03 kg)

Watts Power/Cold Force in Pounds at 100% Voltage/Inches Stroke

Solenoid Model Number	Maximum Stroke In. (mm)	Power in Watts		Force* in Pounds [Kilograms] at 100% Voltage† Stroke in Inches (Millimeters)							
		Seated	Inrush	Hold Continuous	1/8 (3)	1/4 (6)	1/2 (13)	3/4 (19)	1 (25)	1-1/4 (32)	1-1/2 (38)
RP2307B	1 (25)	18	624	25 [11.34] <13> [5.90]	22 [9.98] <12> [5.44]	21 [9.53] <11> [4.99]	17 [7.71] <10> [4.54]	14 [6.35] <8> [3.63]	10 [4.54] <6> [2.72]	—	—
RP2308B	1 (25)	12	696	27 [12.25] <15> [6.80]	25 [11.34] <14> [6.35]	23 [10.43] <13> [5.90]	19 [8.62] <12> [5.44]	15 [6.80] <9> [4.08]	11 [4.99] <7> [3.18]	—	—
RP2309B	1-1/2 (38)	18	1029	32 [14.52] <19> [8.62]	30 [13.61] <18> [8.16]	27 [12.25] <16> [7.26]	22 [9.98] <14> [6.35]	18 [8.16] <11> [4.99]	13 [5.90] <9> [4.08]	8 [3.63] <6> [2.72]	6 [2.72] <4> [1.81]
RP2310B	1-1/2 (38)	12	960	35 [15.88] <20> [9.07]	34 [15.42] <19> [8.62]	31 [14.06] <17> [7.71]	26 [11.79] <15> [6.80]	22 [9.98] <12> [5.44]	17 [7.71] <9> [4.08]	12 [5.44] <7> [3.18]	7 [3.18] <4> [1.81]

* Forces shown are without return spring. Forces shown < > are with return spring. Forces shown in [] are in kilograms.

† To determine the operating current, divide the power (watts) indicated in the above table by the applied voltage. Solenoids will operate at any stroke less than maximum.

Solenoid Dimensions

RP2307B and RP2308B

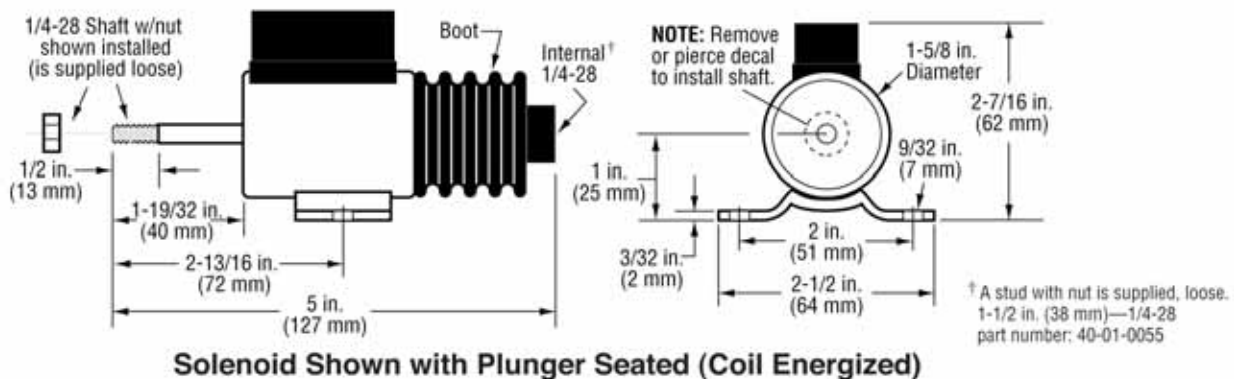

Solenoid Shown with Plunger Seated (Coil Energized)

RP2309B and RP2310B

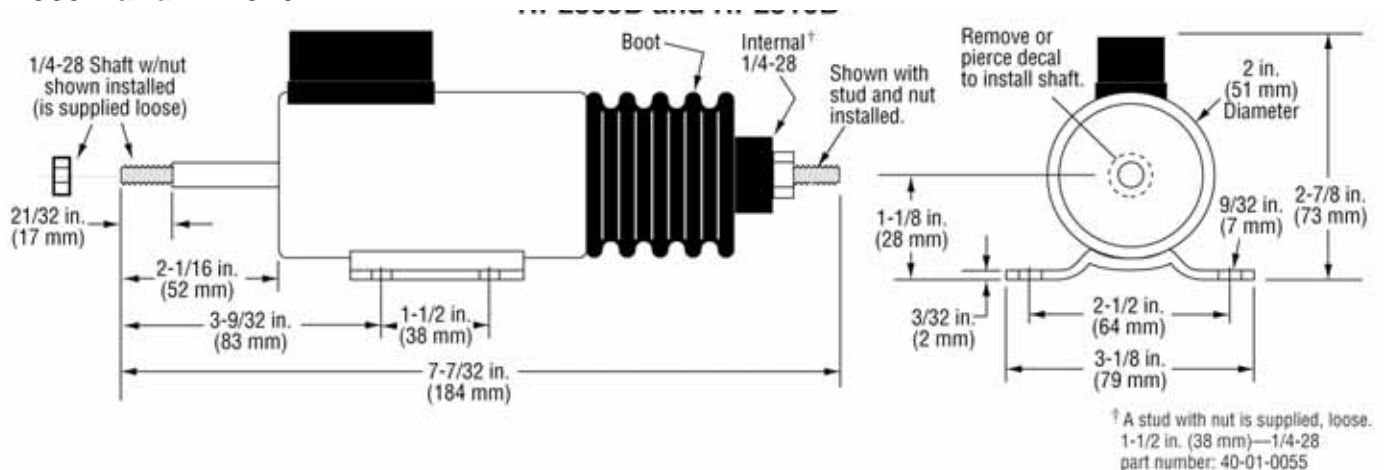

Note 1. Typical operating temperature for single 15 second operation of the energize coil is less than: 140°F(60°C) ± 10°F (6°C) for 1 in. (25 mm) Stroke Solenoids (70°F/21°C Rise above ambient) 120°F(49°C) ± 10°F (6°C) 1-1/2 in. (38 mm) Stroke Solenoids (50°F/10°C Rise above ambient) See **CAUTION** statement on next page and note maximum housing temperature is 185°F (85°C).

Note 2. The energize-coil should not be activated for more than 15 seconds. Longer energize-coil activation times will damage the solenoid.

Note 3. Allow minimum 15 minutes for cooling between activations of energize-coil to avoid damaging the solenoid. (Depends on length of time energize coil is energized.)

Note 4. The energize-coil must fully seat the plunger to allow the hold-coil to function properly.

Warranty - A limited warranty on materials and workmanship is given with this FW Murphy product. A copy of the warranty may be viewed or printed by going to <http://www.fwmurphy.com/warranty>

Typical Wiring Diagrams

NOTE: In either application if the starter hangs, on starters with integral solenoids, the energize coil remains energized.



CAUTION: On certain starter solenoids/contactor relays, current can feed back through the energize terminal from the hold coil and provide a parallel path to ground through the device connected to the energize terminal.

Typical time-delayed shutdown using a 518PH magnetic switch (SD85 is optional)

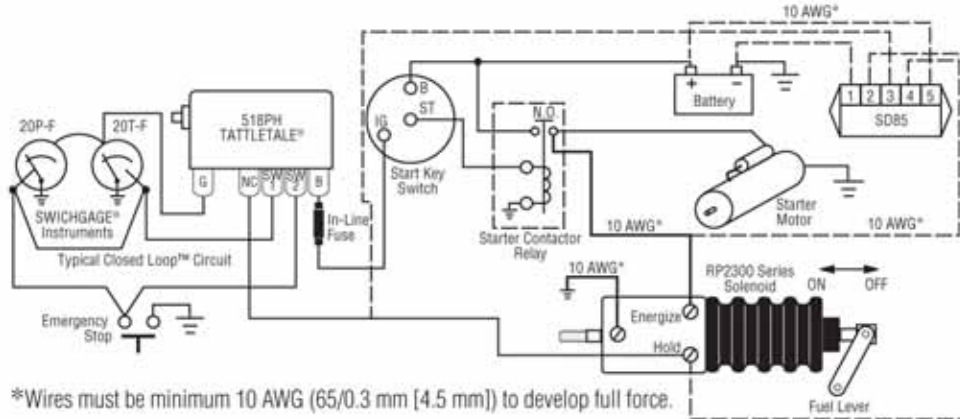

Typical time-delayed shutdown using a 760A magnetic switch (SD85 is optional)

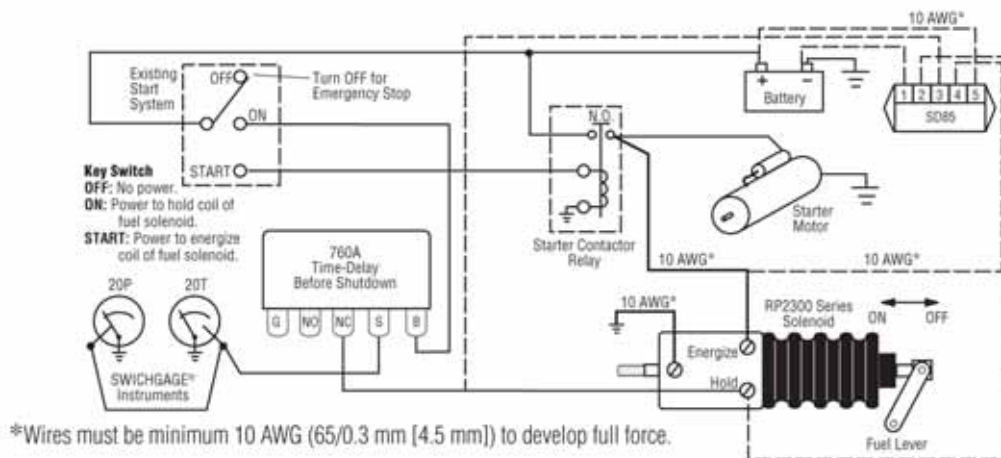

Mechanical Installation

1. Bolt the solenoid securely to the mounting bracket.
2. Connect linkage and check for binding. Plunger should move freely throughout the complete stroke and be allowed to "bottom" at the internal stop of the solenoid.

DO NOT MOUNT WITH BOOT DOWN. DO NOT APPLY ANY GREASE OR LUBRICATION TO PARTS.

IMPORTANT: If the plunger does not seat, it will release prematurely when shifted to the "holding" mode of operation. Readjust linkage to lengthen the plunger stroke. Adjust the yoke in increments of 1/2 turn until plunger will remain in hold position.

Electrical Installation

1. Refer to the diagrams above for typical electric wiring.
2. Use minimum 10 AWG [65/0.3 mm (4.5 mm)] wire size, as noted in the wiring diagrams. A smaller wire will reduce the current available and thus the pulling force. Wire length must be kept to a minimum.

Operation

The solenoid coil is connected to the existing engine starter system or an equivalent circuit. A SD85 is recommended. At starting, both the Energize and Hold-in coils are energized. In the run mode, the Hold-in coil is continuously energized while the Energize coil has to be disconnected, reducing the heating effect and power consumption and avoiding damage to the device.

NOTE: Coils that burn out due to improper electrical hookup, mis-adjustment or improper operation are not covered by Murphy factory warranty.



CAUTION: The solenoid housing is hot to the touch. A temperature rise to 185°F (85°C) is permissible.

NOTE: A cool down period of 15 minutes minimum should be allowed between energized pull in cycles.

Accessories

RPS Linkage Parts and Assemblies

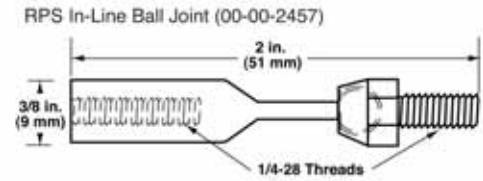
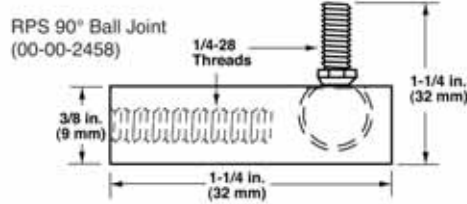
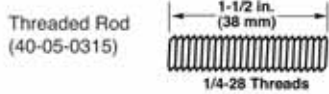

Clevis Yoke Bead Chain Assemblies 65-01-0110



Clevis Yoke Assembly 65-01-0108

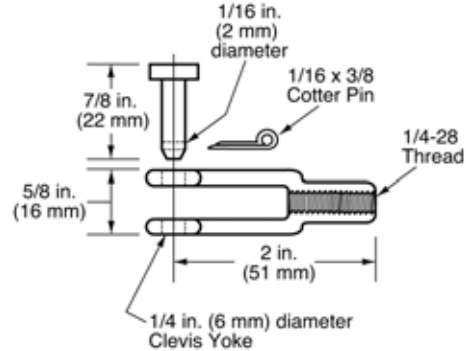

SD85: Solenoid Drive Time Delay

The SD85 is used when the solenoid is duty cycled for short time periods such as 2-position throttle operation. It also provides enhanced operational control for normal on-off applications. The SD85 activates both coils of the solenoid for a short time then de-energizes the Energize-coil. The Hold-in coil remains energized.

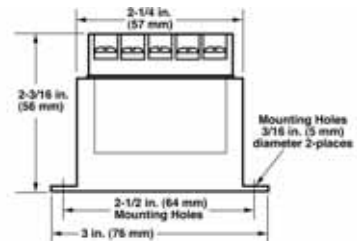

SD85: Specifications

Input Voltage: 8 to 30 VDC

Current Ratings:

- 40 ma standby (quiescent) 8 to 30 VDC
- 75 Amps Pull-in @ 12 VDC
- 1 Amps Hold @ 12 VDC
- 37.5 Amps Pull-in @ 24 VDC
- 0.5 Amps Hold @ 24 VDC
- Terminal #3 2 Amps Maximum
- Terminal #5 112.5 Amps Maximum during Pull-in

NOTE: Wires designated 10 ga. must be at least 10 AWG [65/0.3 mm (4.5 mm)] to develop full force.

