

Shock and Vibration Switch – VS2 Series



Features

- Designed to Detect Shock/Vibration in 3-Planes of Motion
- Fully Adjustable
- Includes Magnetic Latching Feature
- Manual or Electric Reset



LISTED*

The VS2 Series switches are shock sensitive mechanisms for shutdown of engine or electric motor powered equipment. These switches use a magnetic latch to ensure reliable operation. Explosion-proof “EX” models for hazardous locations are available.

Applications

Ideal for use on engines, pumps, compressors, heat exchangers and pumping units, the VS2 Series can be used anywhere shutdown protection from damaging shock/vibration is desired. Switches are field adjustable to sensitivity required in each application.

Specifications

VS2 and VS2C

Case: Equal to NEMA 3R. Suitable for non-hazardous areas.

VS2: Base mount

VS2C: C-clamp mount, includes 45 ft. (13.7 m) 2-conductor cable, and 5 cable clamps.

Contacts: SPDT-double make leaf contacts, 5A @ 480 VAC.

Shipping Weight:

VS2: 2 lb 8 oz. (1.1 kg)

VS2C: 7 lb (3.2 kg)

Shipping Dimensions:

VS2: 8-1/4 x 9-1/4 x 5 in. (210 x 235 x 127 mm)

VS2C: 12 x 7 x 5-1/2 in. (305 x 178 x 140 mm)

VS2EX

Case: Base mount, explosion-proof aluminum alloy housing; meets NEMA 7/IP54 specifications; Class I, Division 1, Groups C & D; UL and CSA listed.

Snap-switches: 2-SPDT snap-switches; 5A @ 480 VAC; 2A resistive, 1A inductive, up to 30 VDC.

Normal Operating Temperature: -40 to 140°F (-40 to 60°C).

Shipping Weight: 4 lb 8 oz. (2 kg)

Shipping Dimensions: 8-1/4 x 9-1/4 x 5 in. (210 x 235 x 127 mm)

VS2EXR

Case: Same as VS2EX.

Snap-switch: 1-SPDT snap-switch and reset coil; 5A @ 480 VAC; 2A resistive, 1A inductive, up to 30 VDC.

Remote Reset: 115 VAC or 24 VDC (specify).

Shipping Weight: 5 lb 8 oz. (2.2 kg)

Shipping Dimensions: 8-1/4 x 9-1/4 x 5 in. (210 x 235 x 127 mm)

VS2EXRB

Case: Explosion-proof aluminum alloy housing; rated Class I, Division 1, Group B hazardous areas.

Snap-switch: 1-SPDT snap-switch with reset coil (option available for 2-SPDT switches); 5A @ 480 VAC; 2A resistive, 1A inductive, up to 30 VDC.

Remote Reset: 115 VAC or 24 VDC (specify).

Shipping Weight: 17 lb 8 oz. (7.9 kg)

Shipping Dimensions: 12 x 12 x 10 in. (305 x 305 x 254 mm)

Basic Operation

Pushing the reset button moves the tripping latch into a magnetically held position. A shock/vibration will move the magnet beyond this holding position, thus freeing the spring loaded tripping latch to transfer the contacts and shutdown the machinery (see dimensional diagrams in the following pages for visual representation of parts).

Remote Reset Option (VS2EXR and VS2EXRB)

The remote reset option includes a built-in electric solenoid which allows reset of tripped unit from a remote location. Available for 115 VAC or 24 VDC.

Dimensions

VS2 and VS2C

The VS2 and VS2C are designed for use in non-hazardous locations. They have leaf type SPDT, double make contacts that can be used for shutdown and/or alarm. They have a slotted sensitivity adjustment located on the side of the case (see drawing below).

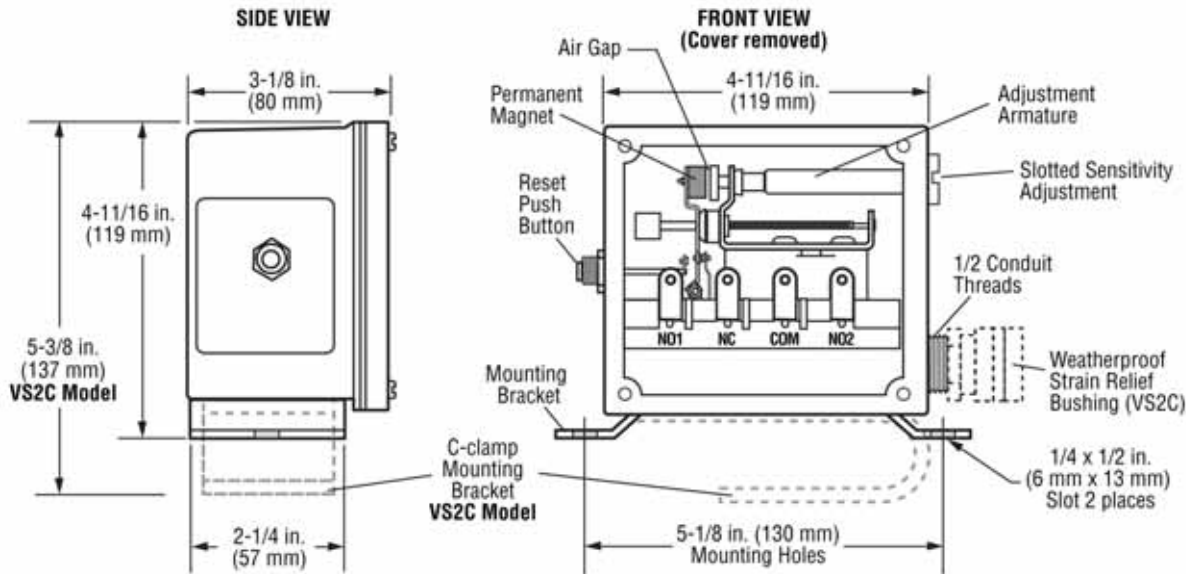
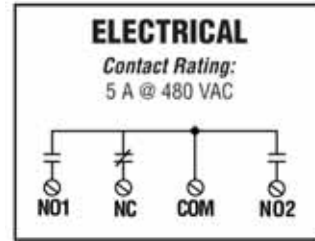

VS2EX

- NEMA 7/IP54 Specifications
- Snap-switch Contacts
- TATTLETALE® Reset Button

Model VS2EX is housed in an explosion-proof enclosure with threaded cover. This enclosure is CSA and UL listed for Class I, Division 1, Groups C & D hazardous locations. In place of the leaf type contacts, 2-SPDT snap-switches are used in this model. Sensitivity is externally adjustable and, when tripped, the VS2EX gives a TATTLETALE® indication on the reset button. It is constructed to meet NEMA 7 specifications.

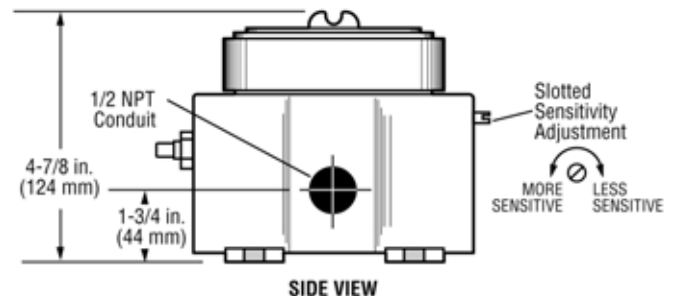
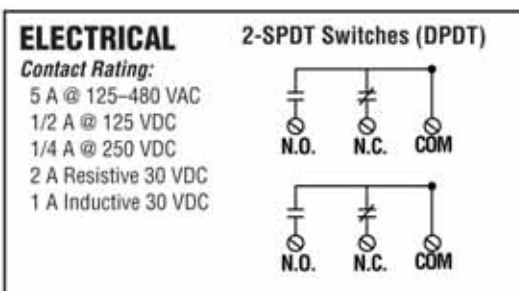
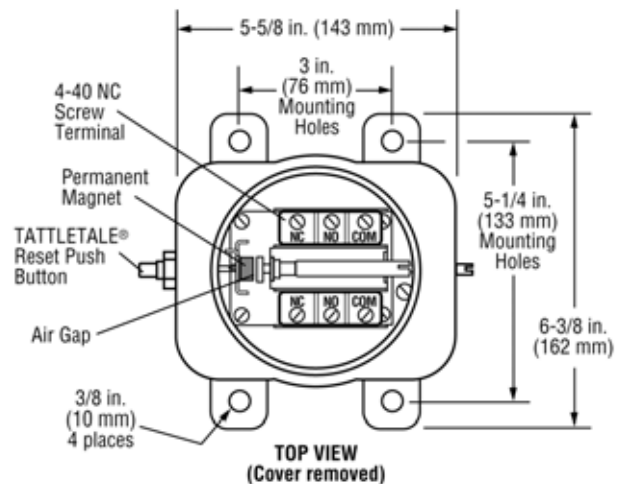

Warranty - A limited warranty on materials and workmanship is given with this FW Murphy product. A copy of the warranty may be viewed or printed by going to <http://www.fwmurphy.com/warranty>

VS2EXR

- Remote Reset Feature
- NEMA 7 Specifications
- Snap-switch Contacts
- TATTLETALE® Reset Button

Model VS2EXR features an electric remote reset feature in addition to the TATTLETALE® reset button. The VS2EXR uses only one SPDT snap-switch and is CSA and UL listed for Class I, Division 1, Groups C & D hazardous locations. It is constructed to meet NEMA 7 specifications.

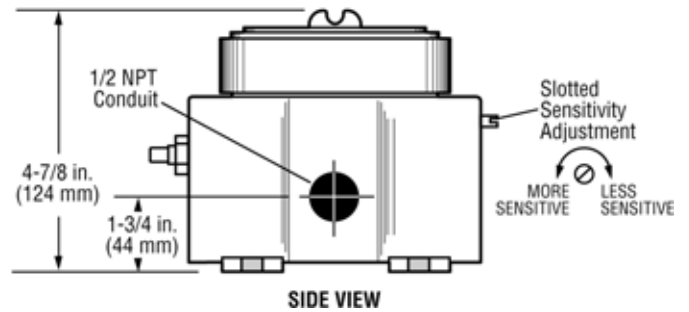
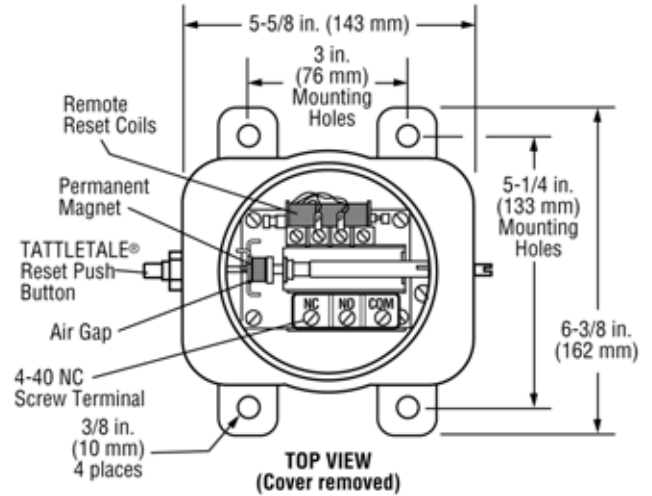

ELECTRICAL	
Contact Rating:	
5 A @ 125-480 VAC	
1/2 A @ 125 VDC	
1/4 A @ 250 VDC	
2 A Resistive 30 VDC	
1 A Inductive 30 VDC	
Remote Reset Rating:	
115 VAC or 24 VDC (Specify)	
350 mA AC/DC	

Remote Reset

SPDT Snap-switch

VS2EXRB

- For Group B Locations
- Snap-switch Contacts
- DPDT Feature Optional

Model VS2EXRB is constructed for use in Class I, Division 1, Group B, hazardous locations. It has, as standard, a SPDT snap-switch and an electric remote reset. Option is available for DPDT snap-switch

ELECTRICAL	
Contact Rating:	
5 A @ 125-480 VAC	
1/2 A @ 125 VDC	
1/4 A @ 250 VDC	
2 A Resistive 30 VDC	
1 A Inductive 30 VDC	
Remote Reset Rating:	
115 VAC or 24 VDC (Specify)	
350 mA AC/DC	

Remote Reset

SPDT Snap-switch

Option SPDT Snap-switch (DPDT)

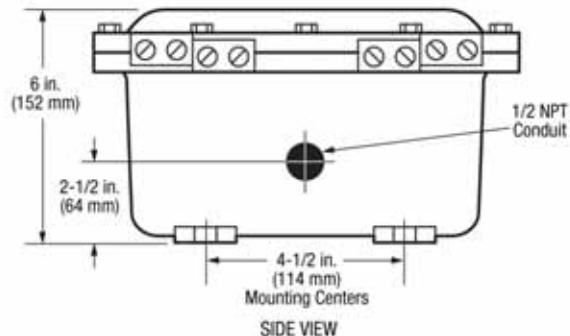
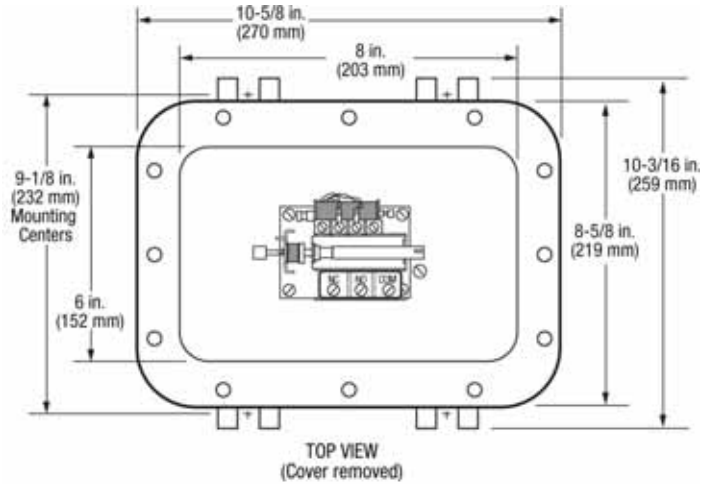

Service Parts

When ordering service parts, specify both part number and description in listing below.

PART NO. DESCRIPTION

VS2 and VS2C

- 20-00-0030 Movement assembly
- 20-00-0031 Glass and gasket assembly
- 20-00-0032 Reset push button assembly
- 20-05-0021 Mounting clamp (VS2C)
- 20-00-0261 Cable clamp assembly (1 each) (VS2C)
- 20-05-0465 2-Conductor electrical cable, 45 feet (13.7 meters) (VS2C)
- 20-00-0137 5 clamps and 45 feet (13.7 meters) of cable (VS2C)

VS2EX

- 20-01-0091 Movement assembly
- 20-05-0087 Cover
- 00-00-0309 Cover gasket
- 20-01-0090 Snap-switch and insulator kit (1 switch per kit)

prior to September 1, 1995.*

20-00-0288 Snap-switch and insulator kit (1 switch per kit) for models manufactured on September 1, 1995 or later.*

- 20-00-0289 C-clamp conversion mounting kit

VS2EXR

- 20-00-0262 Movement assembly
- 20-05-0087 Cover
- 00-00-0309 Cover gasket
- 20-01-0090 Snap-switch and insulator kit (1 switch per kit)

prior to September 1, 1995.*

20-00-0288 Snap-switch and insulator kit (1 switch per kit) for models manufactured on September 1, 1995 or later.*

- 20-00-0049 Reset solenoid assembly (115 VAC)
- 20-00-0234 Reset solenoid assembly (24 VDC)
- 20-00-0289 C-clamp conversion mounting kit

VS2EXRB

- 20-01-0090 Snap-switch and insulator kit (1 switch per kit)

prior to September 1, 1995.*

20-00-0288 Snap-switch and insulator kit (1 switch per kit) for models manufactured on September 1, 1995 or later.*

- 20-00-0057 Inside snap-switch and insulator kit (1 switch per kit) for model VS2EXRB-D

prior to September 1, 1995.*

- 20-00-0058 Outside snap-switch and insulator kit (1 switch per kit) for model VS2EXRB-D

prior to September 1, 1995.*

20-00-0287 Outside snap-switch and insulator kit (1 switch per kit) for model

VS2EXRB-D manufactured on September 1, 1995 or later.*

20-00-0290 Inside snap-switch and insulator kit (1 switch per kit) for model

VS2EXRB-D manufactured on September 1, 1995 or later.*

- 20-05-0077 Adjustment shaft
- 20-00-0262 Movement assembly
- 20-00-0049 Reset solenoid assembly (115 VAC)
- 20-00-0234 Reset solenoid assembly (24 VDC)

*Models with date 0895 and before use old switch. Dated 0995 after, use straight snap-switch arm, no rollers.

How to Order

To order your VS2 Series model use the diagram below.
Part number example: **VS2EXR-24**

