

Maintain Lube Level



Model LR857

- Eliminates Under/OverFill Due to “Human Error”
- Simple Installation
- Automatically Maintains Lube Level
- Low Level Switch
- Models to Fit Varied Applications
- Positive Sealing Thumb-Valve™

Description

Murphy LR857 Lube Level Regulator maintains the crankcase oil level of an engine, pump or compressor. Adjusted to the correct *running-oil-level*, the LR857 will replenish oil as it is used. An integral, low-level switch will alarm and/or shut-down the equipment if supply oil is lost and the equipment continues to use oil.

Application

The LR857 maintains oil level on any size engine, but is recommended for small to medium volume applications and installations that require a 3-wire, snap-action switch.

How the LR857 Maintains Levels

As crankcase oil level drops, the LR857 float also drops and opens the Thumb-Valve™. This allows oil to flow from the supply tank, through the LR857, and into the crankcase. When proper level is attained in the crankcase, the LR857 float rises, causing the Thumb-Valve to close off further oil flow.

The simple and unique Thumb-Valve is non-clogging and provides a positive, leak-free seal.

Flow rate through the 1/8 inch (3 mm) orifice is significant to allow crankcase refill through the LR857.

Specifications

Inlet Connection: 5/8 in. (16 mm) I.D. hose

Outlet Connection: 3/8 NPT

Snap-switch: SPDT rating 10 A @ 125 VAC; 0.5 A @ 125 VDC; 10 A @ 30 VDC.

Conduit Connection: 1/2 NPT

Case: Die cast aluminum

Lens: Polycarbonate

Float: Brass

Flow Rates (see chart below):

Oil with 0.9 specific gravity @ 70°F (21°C)

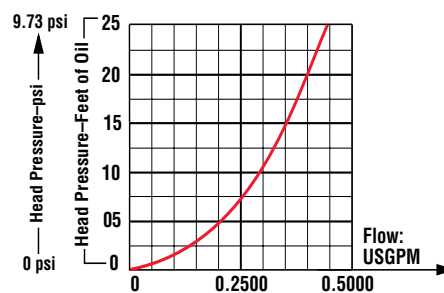

Thumb-Valve Operation

As the equipment uses oil, the float falls, providing immediate level compensation. At FULL position, the float holds the valve closed. If the clean oil supply is depleted and oil level continues to fall, the low level switch will operate an alarm or equipment shutdown.

Simplified Drawing of Thumb-Valve Operation

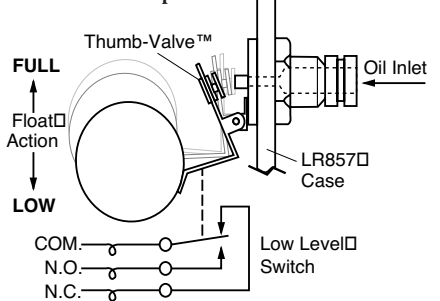

Fittings Kit: 15000420

The 15000420 kit is sold separately. It includes the following items.

Quantity	Description
1	1/4 in. (6 mm) O.D copper cane tube (vent connection)
1	1/4 in. (6 mm) tube x 1/4 male pipe fitting
1	1/2 in. (13 mm) I.D. hose fitting (outlet connection)

Warranty

A limited warranty on materials and workmanship is given with this FW Murphy product. A copy of the warranty may be viewed or printed by going to www.fwmurphy.com/support/warranty.htm

**Products covered by this bulletin comply with EMC Council directive 89/336/EEC regarding electromagnetic compatibility except as noted.

Dimensions

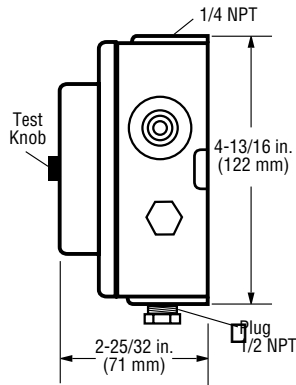
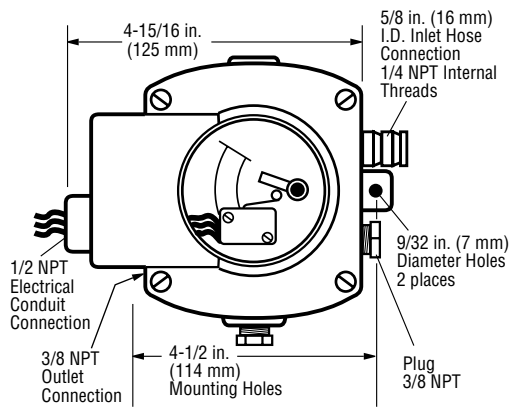

Mounting Brackets with Hardware

Murphy offers two mounting brackets for the LR857. The 15000238 Pipe Bracket Kit fits a 7/8 in. (22 mm) diameter pipe (see typical installation below). The 15010224 universal Flange Kit allows various mounting methods.

15000238

Pipe Bracket Kit

Additional Hardware Supplied

- (2) 1/4-20 x 7/8 inch (22 mm) screws
- (2) 1/4-20 x 1 inch (25 mm) screws
- (4) 1/4-20 hex nuts
- (4) 1/4 inch (6 mm) dia. split washer

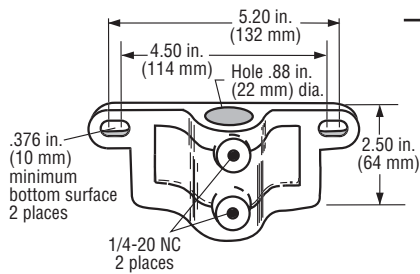

15010224

Universal Flange Kit

Additional Hardware Supplied

- (2) 1/4-20 x 1-1/4 inch (32 mm) bolts
- (4) 1/4 dia. flat washer
- (2) 1/4-20 hex nuts
- (2) 5/16-18 x 1-1/4 inch (32 mm) bolts
- (4) 5/16 dia. flat washer
- (2) 5/16-18 hex nuts

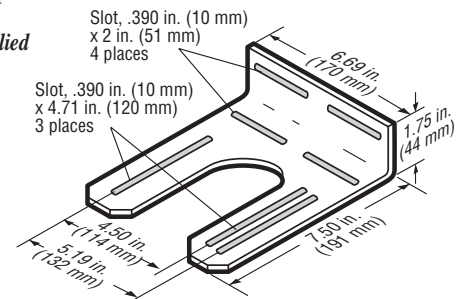

How to Order

Specify model **LR857**

Accessories (Specify part number)

Description	Part Number
Fittings Kit	15000420
Pipe Bracket Kit	15000238
Universal Flange Kit	15010224

Replacement Parts (Specify part number)

Inlet Valve Assembly	15000159
Glass and Switch Ass'y	15000100
Lid Assembly	15000161
Float Assembly (Brass-std)	15000941

LR857 Shipping Dimensions: 9 x 5-1/2 x 6 in. (229 x 140 x 152 mm).

LR857 Shipping Weight: 3 lbs. 6 oz. (1.5 kg).

LR857 Typical Installation

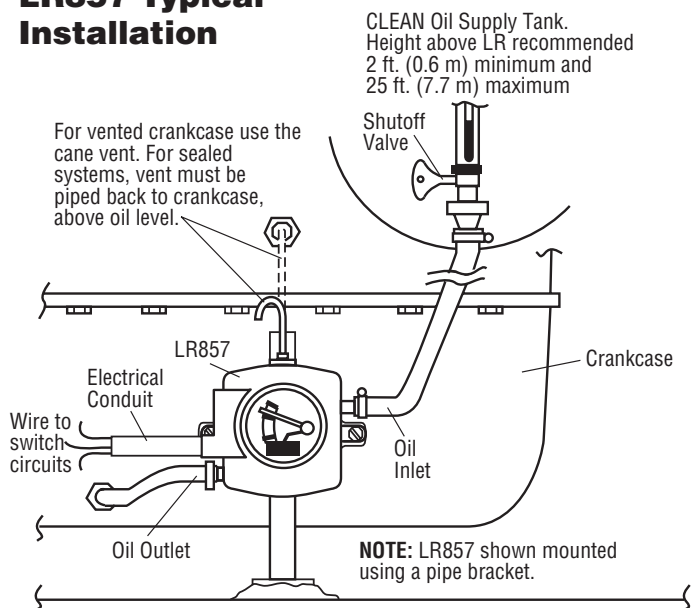

MURPHY 美国Murphy仪表经销商

北京

信德迈科技(北京)有限公司 CNMEC Technology

地址：北京朝阳区胜古中路2号金基业大厦201室

邮编：100029

电话：010-8428 2935 13910962635

传真：010-8428 8762

主页：//www.cnmec.com

电子邮件：sales@cnmec.biz